



LITHIUM IRON PHOSPHATE BATTERY

ELECTRICAL SPECIFICATIONS

Nominal Voltage	12.8 V
Nominal Capacity	300 Ah
Capacity @ 25A	720 min
Energy	3840 Wh
Resistance	30 mΩ
Efficiency	99%
Self Discharge	<3% per Month
Maximum Modules in Series	6

DISCHARGE SPECIFICATIONS

Maximum Continuous Discharge Current	100 A
Peak Discharge Current	200 A (7.5 s ±2.5 s)
PCM Discharge Current Cut-Off	280 A (±50 A)
Recommended Low Voltage Disconnect	11 V
PCM Discharge Voltage Cut-Off	8 V
Reconnect Voltage	9.2 V
Short Circuit Protection	200-600 μs

TEMPERATURE SPECIFICATIONS

Discharge Temperature	-4 to 140 °F (-20 to 60 °C)
Charge Temperature	32 to 131 °F (0 to 55 °C)
Storage Temperature	-4 to 140 °F (-20 to 60 °C)
PCM High Temperature Cut-Off	176 °F (80 °C)

DIMENSIONAL SPECIFICATIONS

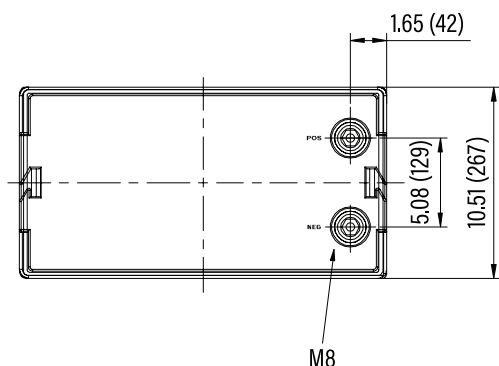

MECHANICAL SPECIFICATIONS

Dimensions (L x W x H)	20.5 x 10.5 x 9.0"
	520 x 267 x 228 mm
Weight	83 lbs (37.5 kg)
Terminal Type	M8
Terminal Torque	80 - 100 in-lbs (9 - 11 N-m)
Case Material	ABS
Enclosure Protection	IP56
Cell Type - Chemistry	Cylindrical - LiFePO ₄

CHARGE SPECIFICATIONS

Recommended Charge Current	50 A
Maximum Charge Current	100 A
PCM Charge Current Cut-Off	280 A (±50 A)
Recommended Charge Voltage	14.2 V - 14.6 V
PCM Charge Voltage Cut-Off	15.6 V
Reconnect Voltage	15.2 V
Balancing Voltage	14.4 V

COMPLIANCE SPECIFICATIONS

Certifications	CE (battery) UN38.3 (battery) UL1642 & IEC2133 (cells)
Shipping Classification	UN 3480, CLASS 9

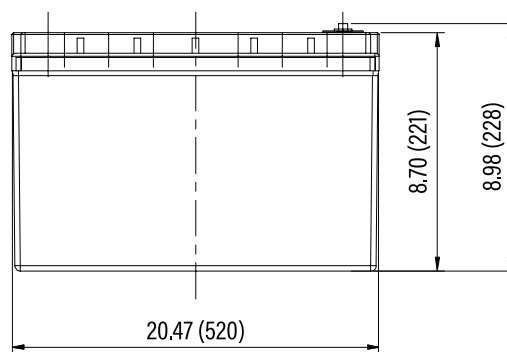



PERFORMANCE CHARACTERISTICS

